

iTracksafe

iTracksafeX GPS User Manual

V1.0.9



Note: The first time you use this device, you need to charge it for more than 3 hours.

Hard wired GPS tracker please hard wired it with vehicle/motorcycle according to the wiring diagram, portable gps tracker just insert sim card can turn on it.

Default: Stop uploading when device in sleep mode. Sleep mode can activate by phone call/sms/move.

Indicator light description

INDICATOR LIGHT STATUS	MEANING
Yellow light -Flash	No GPRS signal
Yellow light -Solid	GPRS connection
Blue light -Flash	No GPS signal
Blue light -Solid	GPS connection
LED light -off	Device power off or sleep

Wiring Diagram For MT-1X,MT5B

Red:Power +/ Black: GND(-)/ Orange: ACC/ Yellow:Cut oil

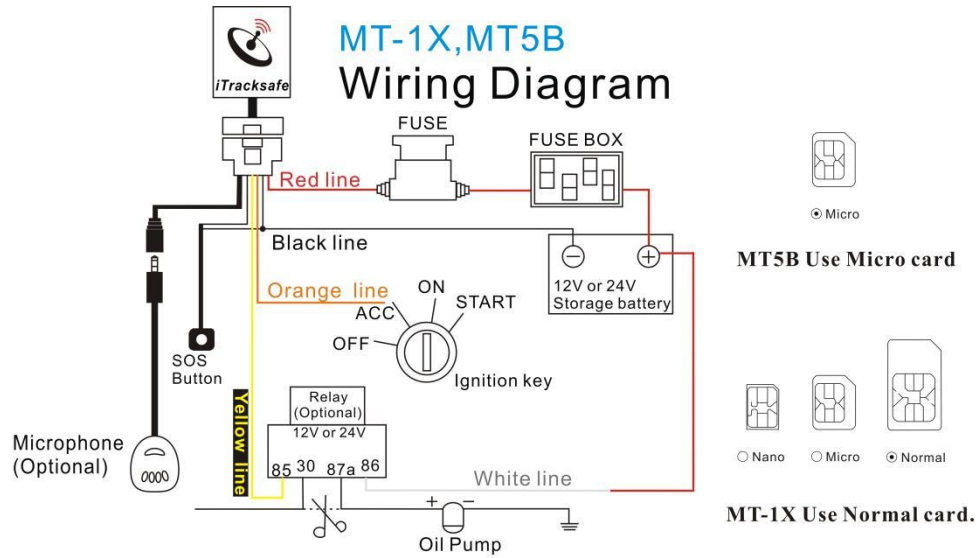

Please choose 12V or 24V relay according the voltage of the car battery.

Wiring Diagram For A1X,MT-1C,MT21,MT5A

Red:Power +/Black: GND(-)/Orange: ACC/ Yellow:Cut oil

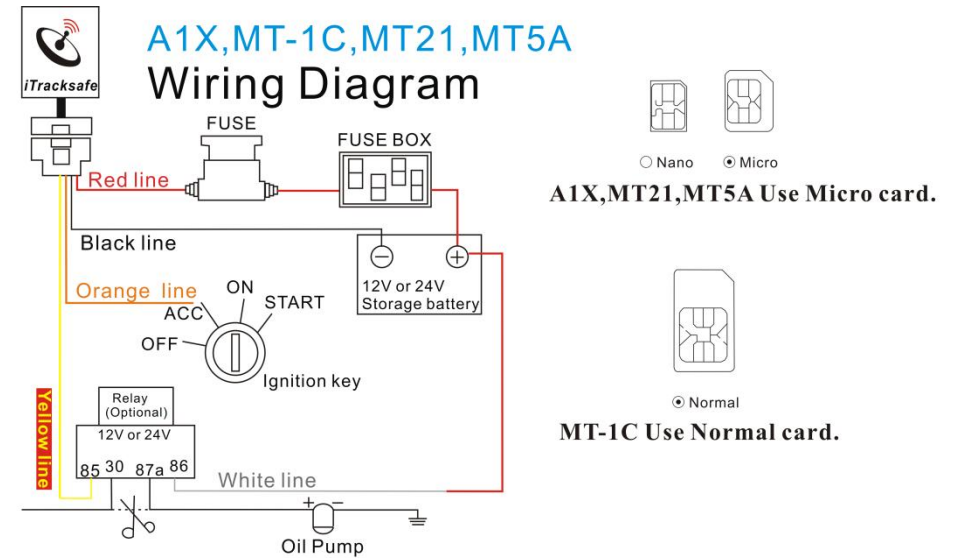

Please choose 12V or 24V relay according the voltage of the car battery.

Wiring Diagram For MT-1

Red:Power +/Black:GND(-)/Orange:ACC

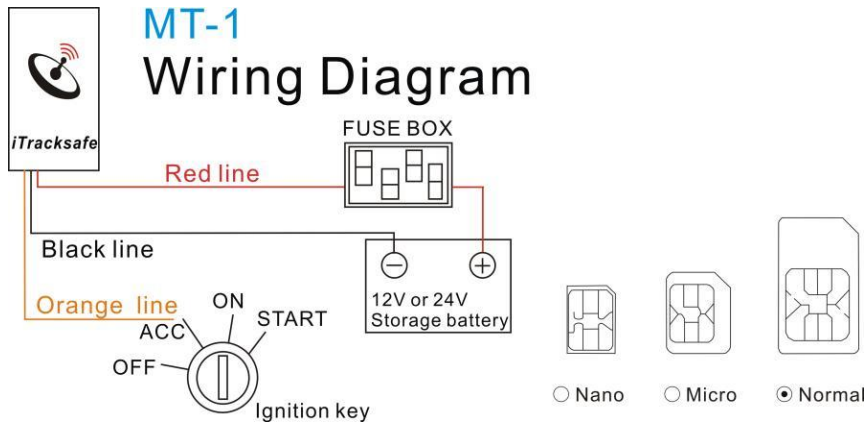

Wiring Diagram For MT22

Red:Power +/ Black: GND(-)/ Orange: ACC/ Yellow:Cut oil

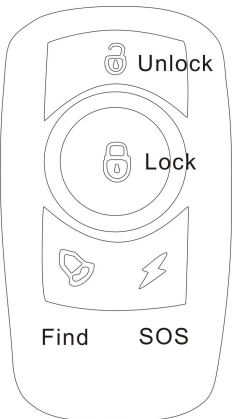

Unlock:Unlock. Make a sound twice.

Lock:Lock the car. Make a sound once.

Find:Find a car. Fifteen sounds.

SOS:Press this button for more than 3 seconds, and the device will send an SOS alarm to the platform or text message.

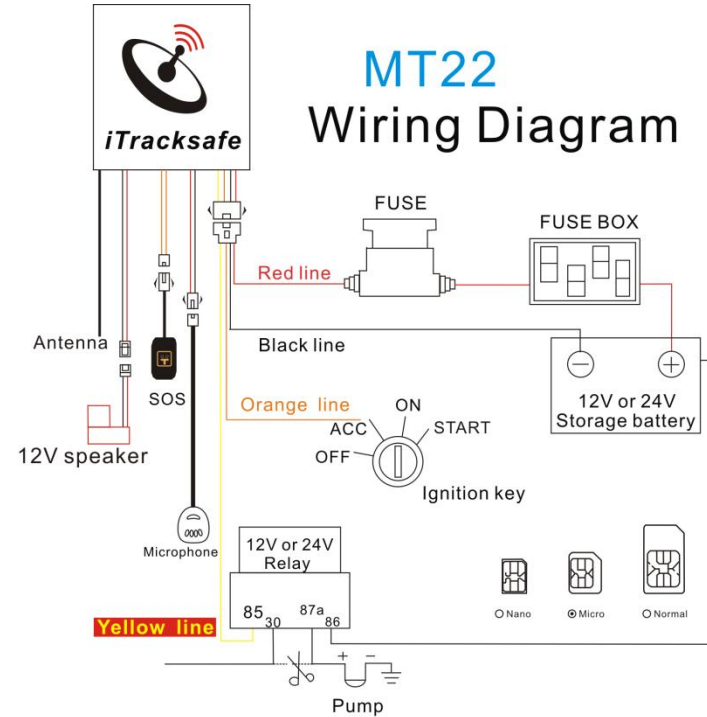

Please choose 12V or 24V relay according the voltage of the car battery.

Please insert a SIM card support GSM/GPRS network into the slot.

1.SMS Tracking

Text the number 6690000 to the gps tracker sim phone number, gps tracker will reply a google maps locationa link.you will receive a Google Maps link of position, when sending message “6690000” to SIM card phone number in tracker .

Command:6690000

Reply:Google link

E.g:6690000

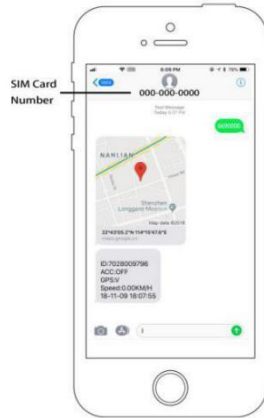

Factory default: ip s2.itracksafe.com 8000

Apn::internet

Default password:0000

2. START ONLINE TRACKING

Set server IP address and Port

Command: 804+user password+space+IP+space+Port

Eg: 8040000 s2.itracksafe.com 8000

Reply: SET SERVER IP AND PORT OK

Set APN by following steps.

Every sim card carrier has own APN content, contact carrier directly to get their APN, or check sim card carrier on internet or put sim card into cell phone to find out APN.

INSTRUCTION	COMMAND	REPLY
E.g 1: Set APN (any existing will be replaced)	803+0000+space+APN Content	apn ok
E.g 2: Set APN , APN username, APN Password(If requires apn user name and apn password)	803+0000+space+APN content+space+APN user name+space+APN Password	apn ok

COMMAND INSTRUCTION TO SET APN

E.g 1

For China mobile SIM Card in China, we got APN information below.

Data APN: internet

APN User name:null

APN Password: null

Send below sms to set APN:8030000 internet

E.g 2:

For MTK mobile SIM card in Nigeria, we got APN information below.

APN name:web.gprs.mtnnigeria.net

APN username:web

APN password:web

Send below SMS to set apn below: 8030000 web.gprs.mtnnigeria.net web web

2.1 WEBSITE TRACKING ON COMPUTER(Operate from the computer platform)

Platform: <https://web.itracksafe.com>

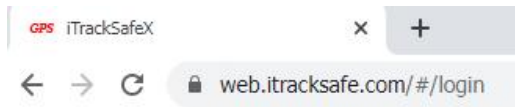

Note:If you do not have computer, then check user manual 2.2.1 directly,register on mobile application "iTrackSafeX" on your mobile phone.

2.1.1 Register login user name via yourself,you can manage multi-devices in one account.Fill in the registration information.

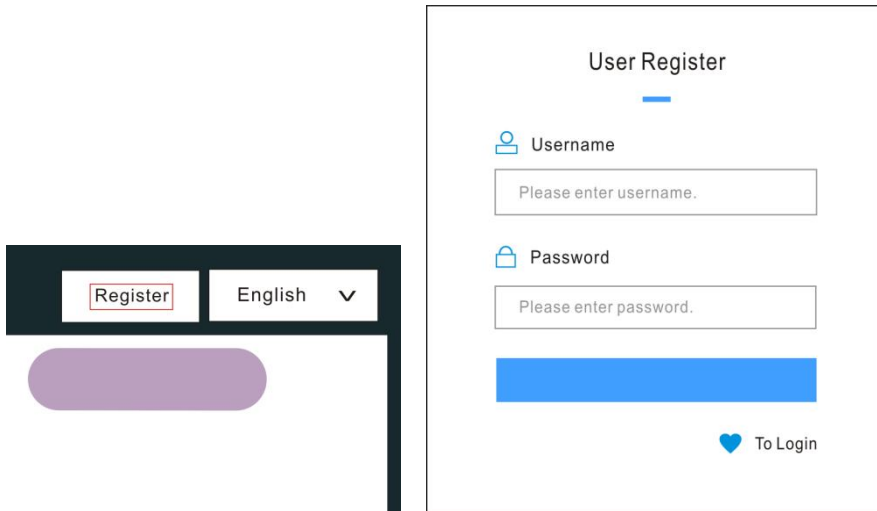

2.1.3 Add device ID and vehicle information

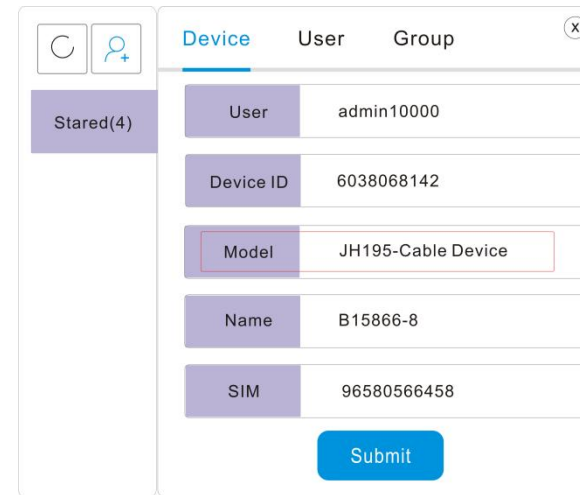

Device ID: the digits number on the device

See below



Model:If the ID is a 10 digit number and Hard Wired device, select JH195, and if the ID is a 10 digit number and Portable device, select JH196.

If the ID is 11 digits and the device is Hard Wired, select JT808, and if the ID is 11 digits Portable, select Jt156.

Select JH134 for VT600X and VT1000 devices.

Name: Device name or license plate number

If logging in using device ID:

Device ID Password: default is Last four digits of ID (Please use this password, if you log in Device ID)

2.1.4 Insert a SIM card support GSM/GPRS network into the slot. Place GPS tracker in an open space without building obstruction, and connect the power supply. The device will work fine in a few minutes.

2.2 APPLICATIONS FOR ANDROID/IOS

Search "iTrackSafeX" in the Apple App Store & Google Play Store or Scan the QR Code to install the applications on your cell phone.



Note: if you already register by computer, then log in by the account you register on computer directly, no need to register again on mobile phone.

2.2.1 Register on mobile phone. Click "Register"

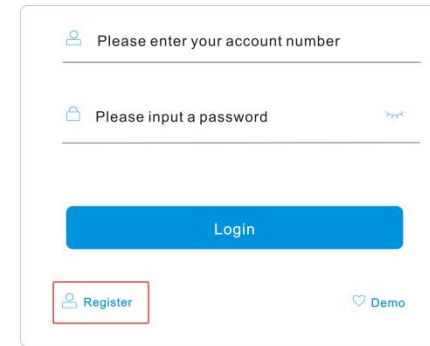

Please enter your account number

Please input a password

Login

Register

Demo

2.2.2 Register login group user name via yourself, you can manage multi-devices in one account.

Fill in the login user name, password.

2.2.3 Log in and select "My", then select "Add Device".

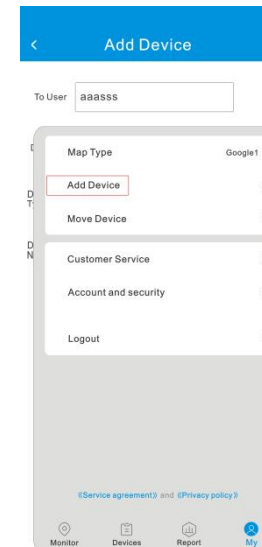

2.2.4 Add Device

Fill in the device ID, device name, phone card number in the device, etc., then click Add.

Device ID: the digits number on the device
See below

A screenshot of a mobile application interface for adding a device. The title bar is blue with a back arrow and the text 'Add Device'. Below the title bar are several input fields: 'To User' with the value 'aaasss', 'Device Id' with '6038052523', 'Device Type' with 'JH195', 'Device Name' with 'tyty', and 'SIM' with '96553586898'. Each field has a small 'x' icon for clearing the text. At the bottom of the form is a blue 'Add' button. Below the form is a grey footer area with links for 'Service agreement' and 'Privacy policy', and a navigation bar with icons for 'Monitor', 'Devices', 'Report', and 'My'.

Device Type:If the ID is a 10 digit number and Hard Wired device, select JH195, and if the ID is a 10 digit number and Portable device, select JH196.

If the ID is 11 digits and the device is Hard Wired, select JT808, and if the ID is 11 digits Portable, select Jt156.

Select JH134 for VT600X and VT1000 devices.

Device Name:Device name or license plate number

SIM:The SIM card number used by the device.

If logging in using device ID:

Device ID Password:default is Last four digits of ID(Please use this password, if you log in Device ID)

2.2.5 Insert a SIM card support GSM/GPRS network into the slot.Place GPS tracker in an open space without building obstruction, and connect the power supply. The device will work fine in a few minutes.

3. Other SMS commands

3.1 Vehicle oil pump power supply(Available for (MT-1C/1X)/A1X/MT21-22/MT5A-5B)

Cut vehicle oil pump power supply: 940+password

Eg: 9400000

Vehicle oil pump power supply will cut.

Recover vehicle oil pump power supply: 941+password

Eg:9410000

Vehicle oil pump power supply will recover.

3.3 Set server IP address and Port

Command: 804+user password+space+IP+space+Port

Eg: 8040000 s2.itracksafe.com 8000

Reply: SET SERVER IP AND PORT OK

3.4. Set Data upload interval time

Command: 805+user password+Space+X

Eg: 8050000 10

Reply: SET OK

Device will upload location to platform every 10 seconds **when car acc is on(moving)**.

Command: 809+user password+Space+X

Eg: 8090000 300

Reply: SET OK

Device will upload location to platform every 300 seconds **when car acc is off(Stopped)**.

3.5 Set Shock Alarm (Available for MT-1C/1X)/A1X/AS3R/MT5A/MT5B/MT21/MT22)

First wire the gps tracker acc cable correct, when the car parks more than 10 minutes not move, and acc off, device will enter into defence alarm, if there's any continuous shock more than 5 seconds, device will send shock alarm SMS to controller phone number .

Remark:Do not put country code when set controller Phone number

Step 1: Set controller phone number

Command: controller phone number+ user password +space+Sequence number (1-3)

Eg: 234098770000 1

Reply : SET USER NUMBER 1 OK.

The controller phone number 1 will be 23409877

Eg: 222198770000 2

Reply : SET USER NUMBER 2 OK.

The controller phone number 2 will be 22219877

Eg: 256908770000 3

Reply : SET USER NUMBER 3 OK.

The controller phone number 3 will be 25690877

Step 2:Enable Shock Alarm

Send: 1810000T05

Reply: SET OK

Delete number

D101# means to delete the first controller phone number

D102# means to delete the second controller phone number

D103# means to delete the third controller phone number

C10# or RCONF View the set controller phone number

Disable Shock Alarm,send: 1800000

3.6 For MT22

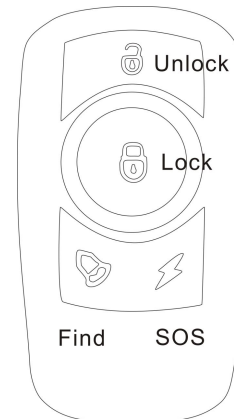

Unlock:Unlock. Make a sound twice.

Lock:Lock the car. Make a sound once.

Find:Find a car. Fifteen sounds.

SOS:Press this button for more than 3 seconds, and the device will send an alarm or text message.

After the device is connected to the relay, there are two ways to cut off the oil, one of which is to choose.

Mode 1 (default), Command: SZCS # YKQOIL=0 User cuts off fuel through external command (default).

Mode 2, Command: SZCS # YKQOIL=2 Remote control lock/unlock control fuel cut-off.. After locking the vehicle, the relay cuts off the oil when ACC is ON. Please connect the ACC cable correctly.

Please contact us for more setup SMS instructions.

4. Troubleshooting

Problem	Answer
Why it said log in user name password error	Please choose correct server www.itracksafe.com
Why device show “unactivated” on platform	Please make sure you set ip port and APN correct, default IP is www.itracksafe.com,port 8000, APN:internet, kindly contact your sim card provider to get correct APN and set
Why device color is yellow on platform	Yellow means no valid gps signal, please put it in open area to get good gps signal
Why the location is not correct	Please make sure you set ip port apn correct, and gps tracker can get valid gps signal
Why it said “register fail”	Both device ID and Asset Name must be unique; and make sure you write correct device ID,if still register fail, please contact us
What type of sim card do i choose	Please put sim card which can support 2G network to gps tracker , make sure sim card has money in it and support gprs internet

Thanks for using our products

If you cannot solve the problem by yourself, please contact our technical support team by writing an E-Mail service@i-trac.cn to us. We will be pleased to help you.

Follow us:



Facebook:<https://www.facebook.com/itracksafe>



Instagram:<https://www.instagram.com/itracksafe>



YouTube:<https://www.youtube.com/c/iTracksafe>

Ascend Group Company Limited(i-Trac GPS)

Address: 5th Floor, A3 Building, Baoying Industrial Zone, Wulian, Longgang District, Shenzhen 518116 China

Phone:+86-755-29042769

