

# iTrackSafeX GPS User Manual

## V3.0.3

**Note: The first time you use this device, you need to charge it for more than 3 hours.**

Hard wired GPS tracker please hard wired it with vehicle/motorcycle according to the wiring diagram, portable gps tracker just insert sim card can turn on it.

Default: Stop uploading when device in sleep mode. Sleep mode can activate by phone call/sms/move.

### Indicator light description For:

(AS3N, MT3, MT4, AS3, AS4, P1, PET03, PET02, MT1-3/4, OBD-2/3/4 with CANBUS, R1)

INDICATOR LIGHT STATUS	MEANING
Yellow light -Flash	No GPRS signal
Yellow light -Solid	GPRS connection
Blue light -Flash	No GPS signal
Blue light -Solid	GPS connection
LED light -off	Device power off or sleep

**Wiring Diagram For MT1-3/4:**

Red:Power +/Black: GND(-)/Orange: ACC

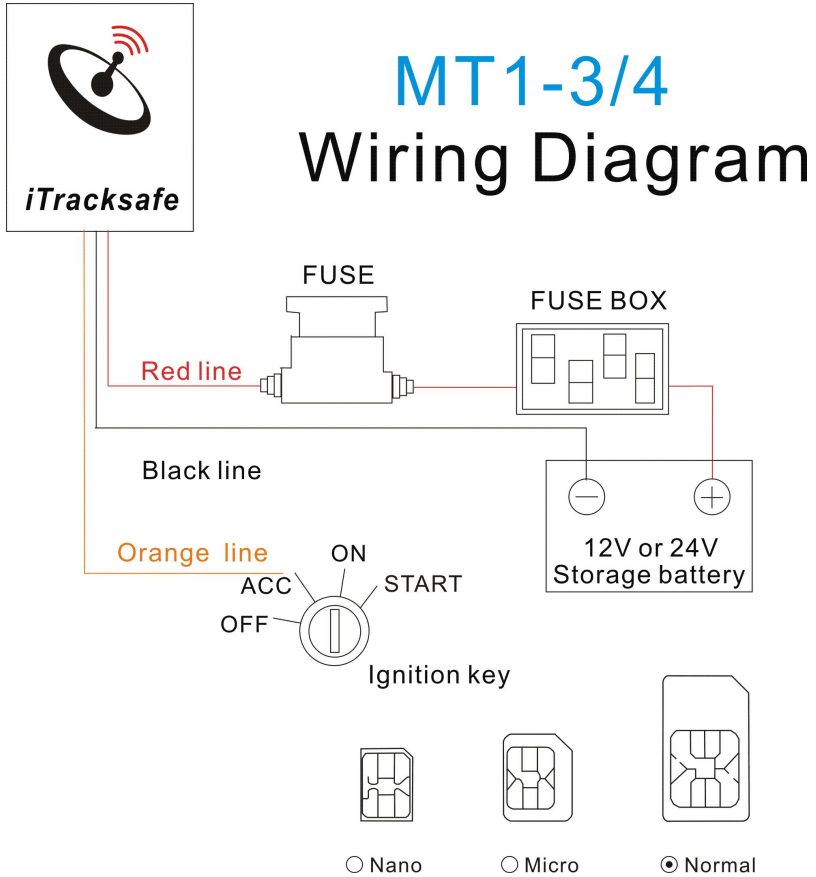

**Wiring Diagram For MT-3 MT-4:**

Red:Power +/Black: GND(-)/Orange: ACC/ Yellow:Cut oil

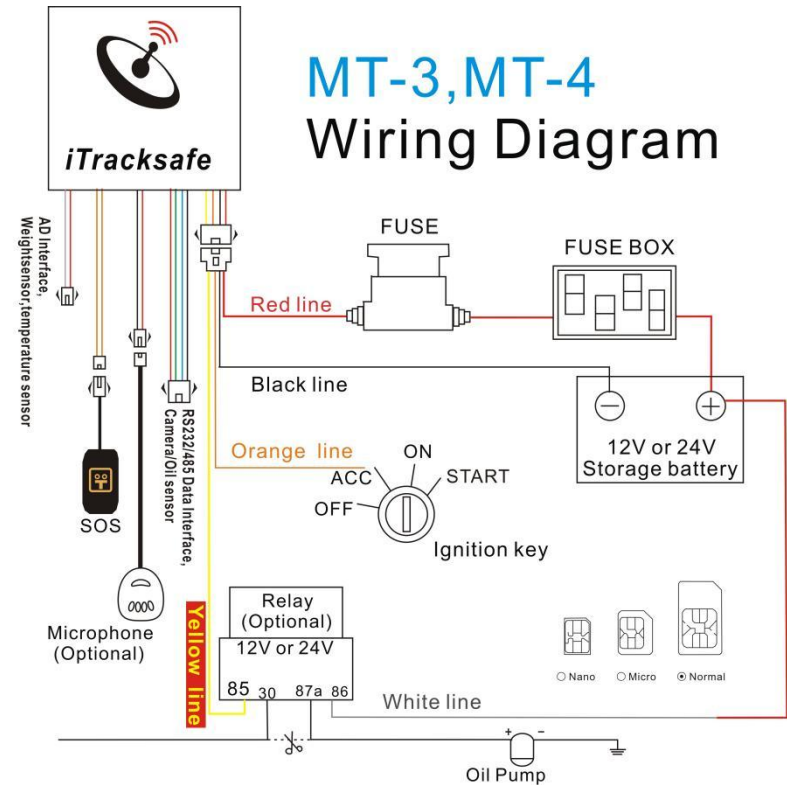

Please choose 12V or 24V relay according the voltage of the car battery.

### Wiring Diagram For R1:

Red:Power +/Black: GND(-)/Blue&Green/ :Cut oil

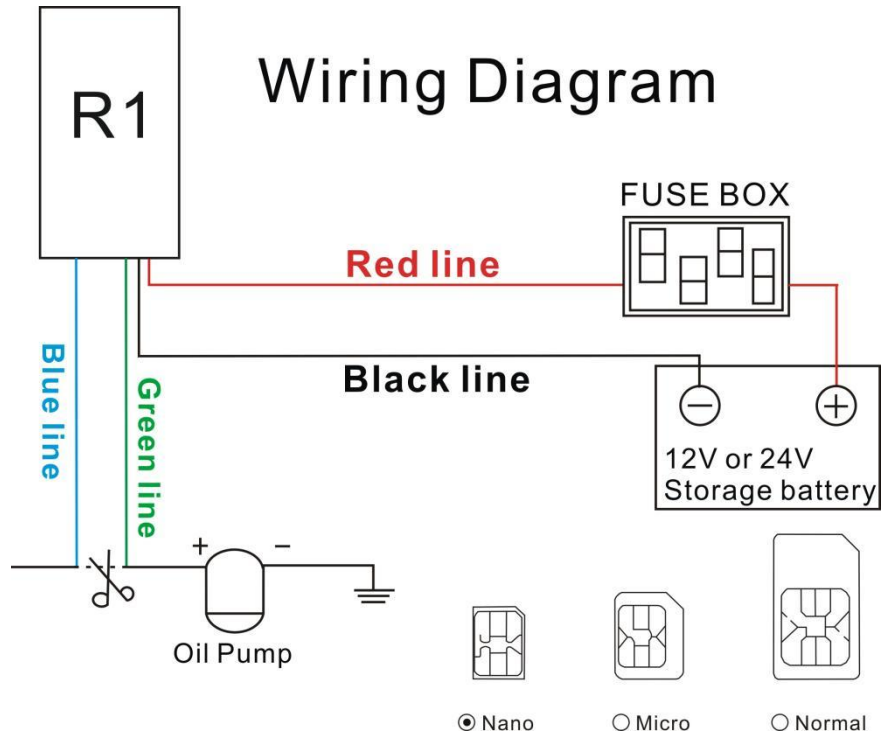

**Please insert a SIM card support GSM/GPRS network into the slot.**

### 1.SMS Tracking

Text the number g1234 to the gps tracker sim phone number, gps tracker will reply a google maps locationa link.you will receive a Google Maps link of position, when sending message “g1234” to SIM card phone number in tracker .

Command:g1234

Reply:Google link

E.G:g1234

Some models send  
g123456

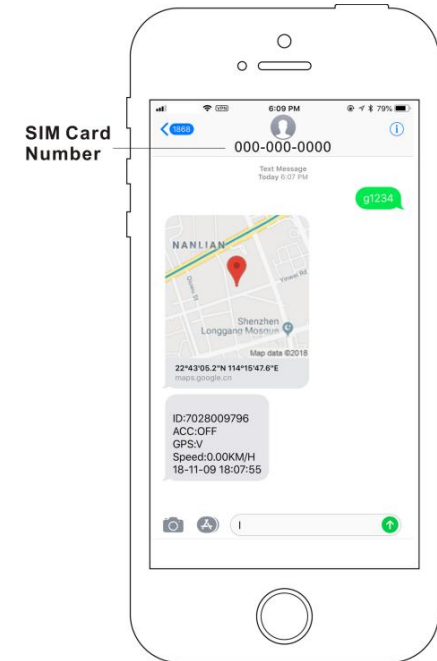

### 2.START ONLINE TRACKING

**Set server IP address and Port(The ip port has been set by default.)**

Command: IP+space+IP/Domain+space+Port

Eg: IP s2.itracksafe.com 8000

Use port 8800 when the device ID is 11 digits.

Eg:IP s2.itracksafe.com 8800

Reply: SET SERVER IP AND PORT OK

**Set APN by following steps.**

Every sim card carrier has own APN content, contact carrier directly to get their APN, or check sim card carrier on internet or put sim card into cell phone to find out APN.

**Gps Tracker default password:123456**

**COMMAND INSTRUCTION TO SET APN**

INSTRUCTION	COMMAND	REPLY
<b>E.g 1:</b> Set APN ( any existing will be replaced)	APN+password+space+APN Content	apn ok
<b>E.g 2:</b> Set APN ,APN username, APN Password(If requires apn user name and apn password)	Setup 1 apn+password+space+APN Content Setup 2 apnuser+password+space+APN username Setup 3 apnpasswd+password+space+APN password	apn ok apnuser ok apnpasswd ok

**E.g 1: (Default apn: internet)**

For China mobile SIM Card in China, we got APN information below.

Data APN: internet

APN User name:null

APN Password: null

Send below sms to set APN:apn123456 internet

**E.g 2:** For mobile SIM card in Nigeria, we got APN information below.

APN name:web.gprs.mtnnigeria.net

APN username:web

APN password:web

Send below SMS to set apn below:

apn123456 web.gprs.mtnnigeria.net

apnuser123456 web

apnpasswd123456 web

**2.1 WEBSITE TRACKING.(Operate from the computer platform)**

Platform: <https://web.itracksafe.com>



**Note:If you do not have computer, then check user manual 2.2.1 directly,register on mobile application "iTrackSafeX" on your mobile phone.**

2.1.1Register login user name via yourself,you can manage multi-devices in one account.Fill in the registration information.

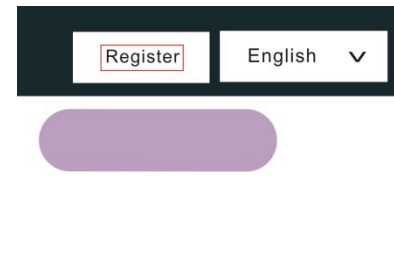

**User Register**

---

Username

Password

To Login

### 2.1.3 Add device ID and vehicle information

The screenshot shows a web form with a sidebar on the left containing a refresh icon, a user icon, and a 'Stared(4)' button. The main form has tabs for 'Device', 'User', and 'Group'. The 'Device' tab is active and contains the following fields:

User	admin10000
Device ID	6038068142
Model	JH195-Cable Device
Name	B15866-8
SIM	96580566458

At the bottom of the form is a blue 'Submit' button.

Device ID: the digits number on the device

See below



Model: If the ID is a 10 digit number and Hard Wired device, select JH195, and if the ID is a 10 digit number and Portable device, select JH196.

If the ID is 11 digits and the device is Hard Wired, select JT808, and if the ID is 11 digits Portable, select Jt156.

Select JH134 for VT600X and VT1000 devices.

Name: Device name or license plate number

If logging in using device ID:

Device ID Password: default is Last four digits of ID (Please use this password, if you log in Device ID)

2.1.4 Insert a SIM card support GSM/GPRS network into the slot. Place GPS tracker in an open space without building obstruction, and connect the power supply. The device will work fine in a few minutes.

### 2.2 APPLICATIONS FOR ANDROID/IOS

Search "iTrackSafeX" in the Apple App Store & GooglePlay Store or Scan the QR Code to install the applications on your cell phone.



**Note: if you already register by computer, then log in by the account you register on computer directly, no need to register again on mobile phone.**

### 2.2.1 Register on mobile phone. Click “Register”

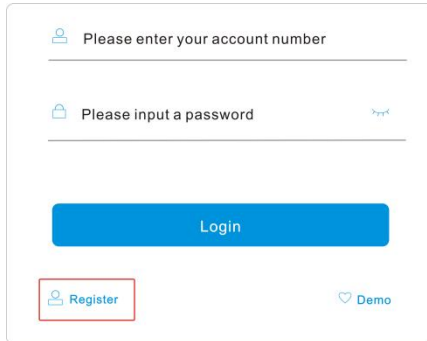

Please enter your account number

Please input a password

Login

Register

Demo

### 2.2.2 Register login group user name via yourself, you can manage multi-devices in one account.

Fill in the login user name, password.

### 2.2.3 Log in and select "My", then select “Add Device”.

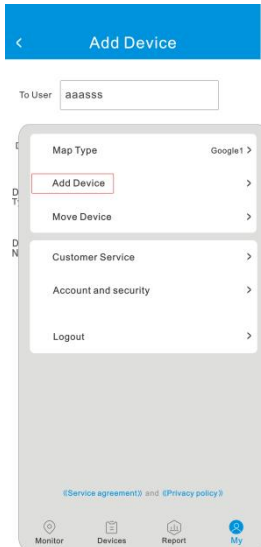

Add Device

To User: aaasss

Map Type Google 1 >

Add Device >

Move Device >

Customer Service >

Account and security >

Logout >

Monitor Devices Report My

### 2.2.4 Add Device

Fill in the device ID, device name, phone card number in the device, etc., then click Add.

Device ID: the digits number on the device

See below

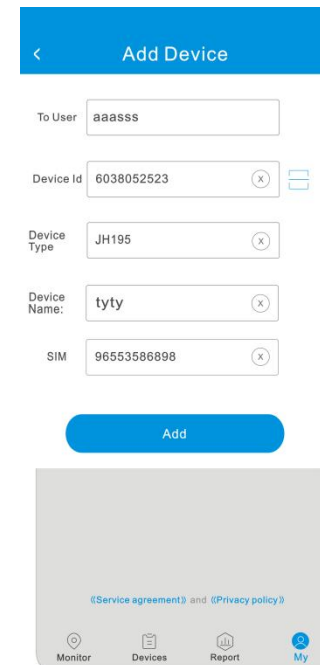

Add Device

To User: aaasss

Device Id: 6038052523

Device Type: JH195

Device Name: tyty

SIM: 96553586898

Add

Service agreement and Privacy policy

Monitor Devices Report My

**Device Type:**If the ID is a 10 digit number and Hard Wired device, select JH195, and if the ID is a 10 digit number and Portable device, select JH196.

**If the ID is 11 digits and the device is Hard Wired, select JT808, and if the ID is 11 digits Portable, select Jt156.**

**Select JH134 for VT600X and VT1000 devices.**

**Device Name:**Device name or license plate number

**SIM:**The SIM card number used by the device.

**If logging in using device ID:**

**Device ID Password:**default is Last four digits of ID(Please use this password, if you log in Device ID)

**2.2.5 Insert a SIM card support GSM/GPRS network into the slot.Place GPS tracker in an open space without building obstruction, and connect the power supply. The device will work fine in a few minutes.**

### 3.Other SMS commands

#### 3.1 Vehicle oil pump power supply(Available for MT-3,MT-4,R1 etc)

Cut vehicle oil pump power supply: DY

Eg: DY, Vehicle oil pump power supply will cut.

Recover vehicle oil pump power supply:KY

Eg:KY, Vehicle oil pump power supply will recover

#### 3.2 Set server IP address and Port(The ip port has been set by default.)

Command: IP+space+IP/Domain+space+Port

Eg: IP s2.itracksafe.com 8000

**Use port 8800 when the device ID is 11 digits.**

**Eg:IP s2.itracksafe.com 8800**

Reply: SET SERVER IP AND PORT OK

#### 3.3. Set Data upload interval time

Command: FREQ,password,X

Eg: FREQ,123456,12

Reply: SET OK

Device will upload location to platform every 12 seconds **when car ACC is on(Moving)**

Command: STATIC,password,X

Eg: STATIC,123456, 180

Reply: SET OK

Device will upload location to platform every 180 seconds **when car ACC is off(Stopped)**

### 3.4 Set Shock Alarm

First wire the gps tracker acc cable correct,when the car parks more than 10 minutes not move,and acc off,device will enter into defence alarm,if there' s any continous shock more than 5 seconds,device will send shock alarm SMS to controller phone number.

**Remark:Do not put country code when set controller Phone number**

#### Step 1: Set controller phone number (1-3)

Command:101#controller phone number#

Eg:101#13712345678#

Reply:OK

Command:102#controller phone number#

Eg:102#13812345678#

Reply:OK.

Command:103#controller phone number#

Eg:103#13912345678#

Reply:OK.

#### Step 2:Enable defense

**Send: SF**

Reply:SET OK

#### Step 3:Enable shock alarm SMS.

Send: 125#

Reply:SET OK

**Delete number**

- D101# Delete the first number
- D102# Delete the second number
- D103# Delete the third number
- C10# View the set controller phone number

**Disable Shock Alarm,send: CF**

**Remark:**

**Main power off alarm will send a SMS and call the controller phone number 1,2,3.The shock alarm only send SMS to controller phone number 1,2,3. Do not call. SOS alarms send SMS and dial the controller phone number 2 and 3.**

Please contact us for more setup SMS instructions.

**3. Troubleshooting**

Problem	Answer
Why it said log in user name password error	Please choose correct server www.itracksafe.com
Why device show “unactivated” on platform	Please make sure you set ip port and APN correct, default IP is www.itracksafe.com,port 8000, APN:internet, kindly contact your sim card provider to get correct APN and set
Why device color is yellow on platform	Yellow means no valid gps signal, please put it in open area to get good gps signal
Why the location is not correct	Please make sure you set ip port apn correct, and gps tracker can get valid gps signal
Why it said “register fail”	Both device ID and Asset Name must be unique; and make sure you write correct device ID,if still

	register fail, please contact us
What type of sim card do i choose	Please put sim card which can support 2G network to gps tracker , make sure sim card has money in it and support gprs internet

**Thanks for using our products**

If you cannot solve the problem by yourself, please contact our technical support team by writing an E-Mail [service@i-trac.cn](mailto:service@i-trac.cn) to us. We will be pleased to help you.

**Follow us:**



**Facebook:**  
<https://www.facebook.com/itracksafe>



**Instagram:**  
<https://www.instagram.com/itracksafe>



**YouTube:**  
<https://www.youtube.com/c/iTracksafe>

**Ascend Group Company Limited(i-Trac GPS)**

Address: 5th Floor, A3 Building, Baoying Industrial Zone, Wulian, Longgang District, Shenzhen 518116 China

Phone:+86-755-29042769

